



PLAY·EXPERIENCE·LEARN

"CHILDREN DO NOT PLAY TO LEARN. BUT THEY LEARN. BECAUSE THEY PLAY."



PLAYWELL ENTERPRISES LTD.

1399 Kennedy Road, Unit 5A
Scarborough, Ontario, M1P 2L6 Canada
TOLL FREE 1 800 387 2587
PHONE 416-439-0044
teresita@playwellcanada.com
www.playwelledu.com



2025

CLASSROOM FURNITURE CATALOGUE



CLASSROOM FURNITURE CATALOGUE

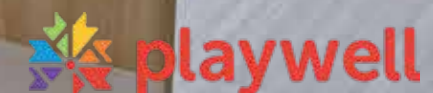

The setting up of nurseries and kindergartens promotes autonomy.
 Children orient themselves in a space that offers suitable places for every moment of daily life: playing and activities, lunch, or rest.

The furniture organizes the space.
 It completes the architecture of the building.
 It divides very large rooms into different areas.
 It creates places for different activities.
 It builds a network of learning opportunities and activities.



Giovanni Fumagalli

Giovanni Fumagalli

Senior architect from Italy dedicated in kindergartens and schools for over 20 years.

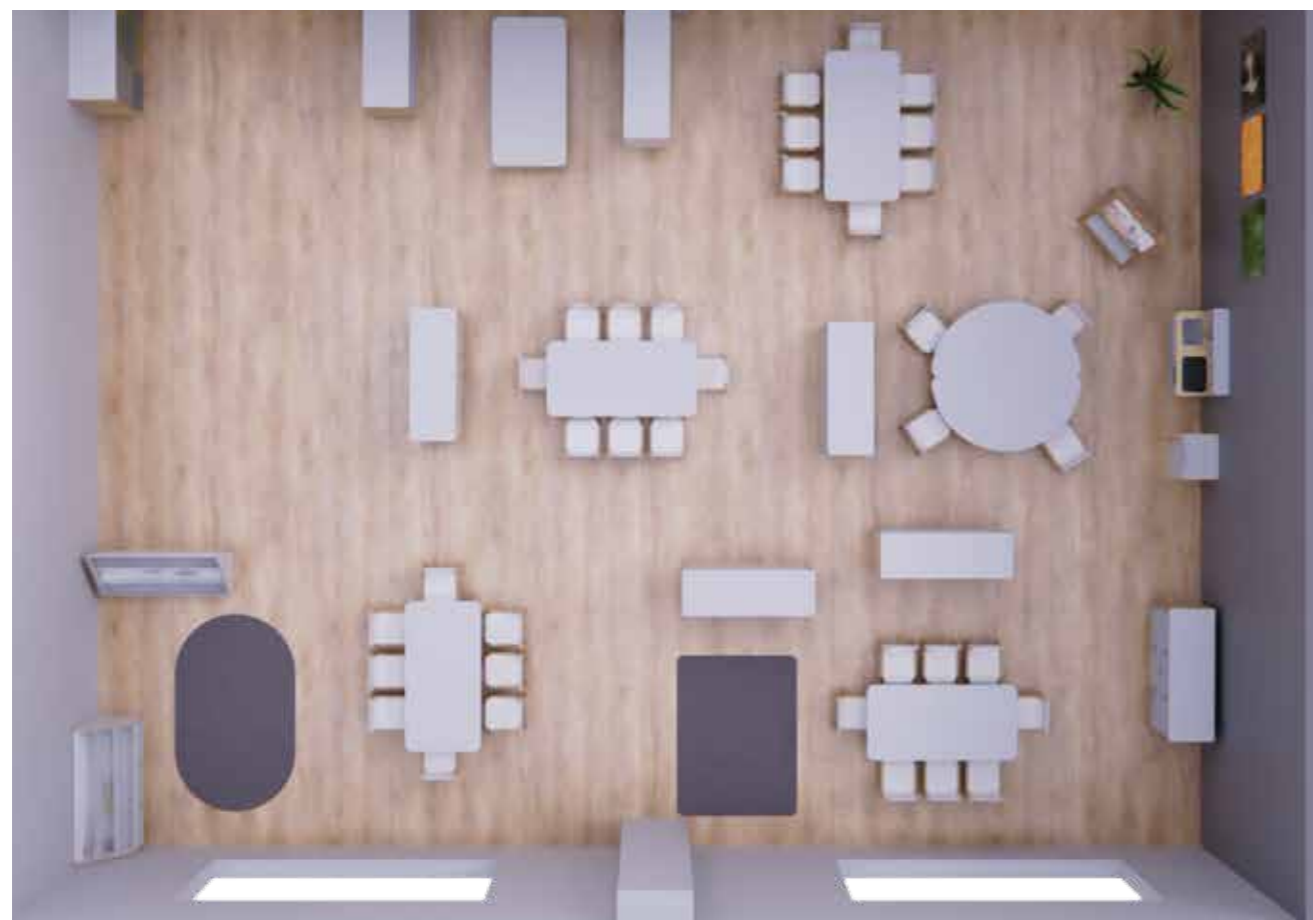

CONTENT

Tables	10
Chairs	14
Cabinets	20
Cloarkroom	35
Library	36
Cots	37
Infant & Toddler Furniture	40
Baskets & Storage	43



Furniture

Furniture

CONCEPT AND GOALS



The new line of Beleduc furniture for nurseries and kindergartens features a linear, essential, and minimalist design with the goal of creating a peaceful and bright environment that is welcoming to children.

The project places children at the center, with furnishing that shapes the space where they move, live, play, and express themselves. The furniture serves as a foundation for games, experiences, and relationships, and should create space rather than make use of it.

A few essential colors coexist harmoniously within the space, creating an environment where the new furnishings are ready to showcase children's drawings and creations.

SOURCES OF INSPIRATION

Beleduc furniture is linear and modern, inspired by Italian humanistic culture, Scandinavian design, and Asian minimalism. These solid and universal sources of inspiration are well-known and loved all over the world. This project has been guided by certain images that have pointed us in a new direction.

The new furniture line will follow these sources of inspiration and continue to grow, develop, and become more enriched.



Italian humanistic culture



Scandinavian design



Asian minimalism

DESIGN KEYWORDS

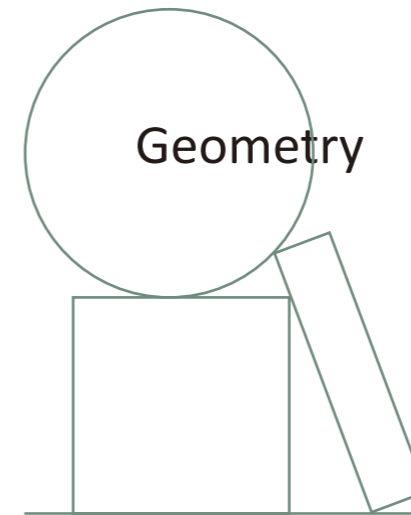

The design of Beleduc furniture is guided by clear geometry, with horizontal lines, squares, and circles which serve as the basic element of each object. These elementary forms are easy to understand and convey a sense of order and serenity. They also provide a great background for more complex objects. By developing designs around elementary geometric shapes, we create versatile, flexible and welcoming spaces.



COLOR PALETTE

Simplicity Lightness Harmony

Three particular colors - yellow, green and blue - serve as chromatic accents that can be found in some of our furniture pieces. We carefully select materials and colors to create a wide range of compositions.

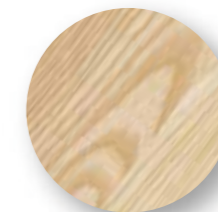

DIVERSIFIED FURNITURE

Our school furniture is carefully crafted through observation of children and their activities in nurseries and kindergartens.

Our team of designers, educators, and craftsmen collaborate to reinterpret common objects in original ways and create new items that offer unique possibilities and ways of use.



INFINITE COMPOSITIONS

Our furnishings are modular elements designed to create spaces, much like the bricks in a wall, a structure made of wood, or the pieces of a mosaic. Simple, linear elements without decorations are used to create welcoming, rational, and elegant arrangements.



DIFFERENT LEARNING ENVIRONMENTS

The new range features a series of different pieces that are beautiful, practical and durable. These include shelving-cabinets, tables, chairs and cots. Beleduc furniture will introduce a unique and modern look to any high-quality learning environment.



HIGH QUALITY

Our products are made of sturdy plywood and feature an easy-to-clean melamine oak finish.

We take safety and durability seriously, which is why all our products undergo rigorous testing in accredited laboratories to ensure they meet our high standards of safety and resistance.



TABLES

Highlights

The Beleduc table range features six unique shapes and is available in natural oak and white finishes. The tabletops are water-resistant and scratch-resistant, ensuring durability. Each tabletop includes soft PU edges that provide a smooth touch while also being scratch and water resistant. For convenience, the table legs and tops are packed separately, allowing for easy assembly and customizable combinations.



Pick a Table Top



846107 Emmanuele Half Circle Table Top
White 48"D: 1200x600mm/47.2x23.6inches
848134 Emmanuele Half Circle Table Top
Oak 48"D: 1200x600mm/47.2x23.6inches



846093 Emmanuele Round Table Top
White 36"D: 900x900mm/35.4x35.4inches
846118 Emmanuele Large Round Table Top
White 48"D: 1200x1200mm/47.2x47.2inches
848135 Emmanuele Large Round Table Top
Oak 48"D: 1200x1200mm/47.2x47.2inches
848133 Emmanuele Round Table Top
Oak 36"D: 900x900mm/35.4x35.4inches



846131 Emmanuele Doughnut Table Top
White 48"D: 1200x1200mm/47.2x47.2inches
848136 Emmanuele Doughnut Table Top
Oak 48"D: 1200x1200mm/47.2x47.2inches

O=Oak
W=White

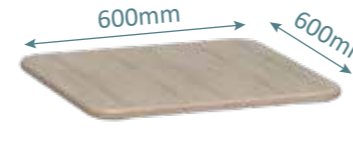

848131 Santino Square Table Top
Oak 24x24": 600x600mm/23.6x23.6inches
846068 Santino Square Table Top
White 24x24": 600x600mm/23.6x23.6inches

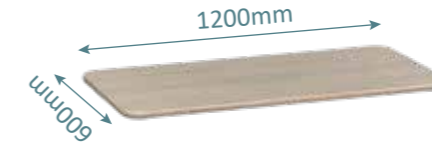

848132 Santino Rectangle Table Top
Oak 48x24": 1200x600mm/47.2x23.6inches
846082 Santino Rectangle Table Top
White 48x24": 1200x600mm/47.2x23.6inches

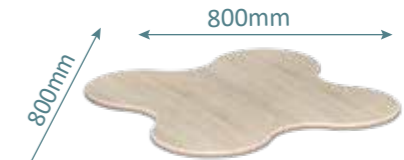

848137 Emmanuele Flower Table Top
Oak 80x80": 800x800mm/31.5x31.5inches
846142 Emmanuele Flower Table Top
White 80x80": 800x800mm/31.5x31.5inches

Choose Table Legs

The non-adjustable table legs are designed with five standard height options to meet international standards. It also has a leveler at the base made of plastic which also acts as a protector. Constructed from metal with a natural oak or white finish, these legs are crafted to perfectly complement all tabletop styles. Assembly is quick and effortless: simply attach the legs to the pre-mounted metal plates on the tabletop, completing the setup in seconds.



Metal legs
White or wooden color coating

Various Combinations

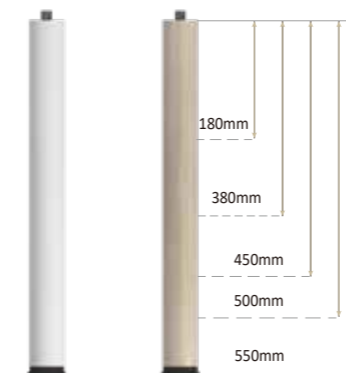
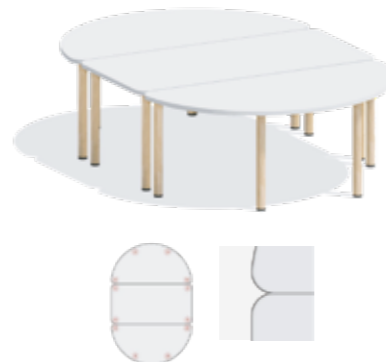
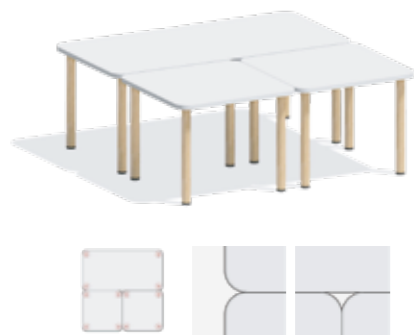

846666 (180mm/7.1inches)
848138 (380mm/15inches)
846156 (450mm/17.7inches)
846157 (500mm/19.7inches)
846158 (550mm/21.7inches)
846665 (180mm/7.1inches)
848139 (380mm/15inches)
846153 (450mm/17.7inches)
846154 (500mm/19.7inches)
846155 (550mm/21.7inches)

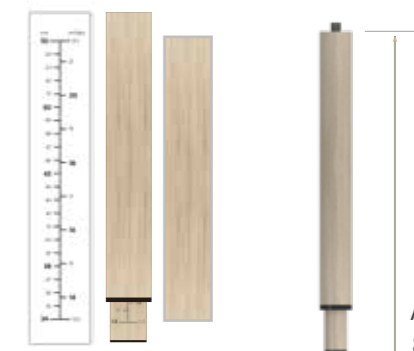

Ajustable from 350 to 550mm
848371 (H350-550mm)
(H13.8-21.7inches)



By rotating the inside pillar, the height of the leg can be changed to suit the room's requirements. The adjustable height ranges from 35cm to 55cm (13.8 inches to 21.7inches), with a clear turning scale marked on the inner pillar for easy reference. Made from metal materials with a natural oak finish, it complements the table tops perfectly.



848693 Round Basin
 This round basin is perfect for individual use and pairs seamlessly in both colour and size with the doughnut tables. Made from durable PP material.
Product Size: 500x500x150mm
 19.7x19.7x5.9inches
Package Size: 53x53x26cm
 20.9x20.9x10.2inches
QTY/CTN: 4pcs

846129 Emmanuele Spin Tray
 This natural plywood rotating plate is designed for use on any Beleduc table, making it easier to share resources. It features rubber feet underneath to prevent scratches and allows for smooth rotation on the table top. No assembly required. 50cm D x 1.8cm H/19.7 D x 0.7 inches H
Product Size: 500x500x18mm
 19.7x19.7x0.7inches
Package Size: 51x51x3.2cm
 20.1x20.1x1.3inches
QTY/CTN: 1pcs



The tabletop is made from plywood laminated with a polyurethane (PU) surface, featuring smooth edges. It is easy to clean, scratch resistant, and waterproof.
 Table top thickness: 22mm/0.9inches



Beleduc Chair Range

The Beleduc chair range features a wooden frame with a natural oak finish and white-colored back and seat, offering a sturdy and durable design. The 18mm (0.7 inches) thick plywood structure supports a weight capacity of up to 150kgs (330lbs). The chairs are fully assembled and shipped in a durable carton box.

Wooden Chair Illiana



The seat and backrest is made of ABS materials

18mm (0.7inches) plywood

Solid wood with white lacquer

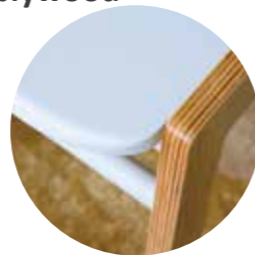

CHAIRS



The Beleduc chair range features a wooden frame with a natural oak finish and white ABS back and seat, offering a sturdy, durable design. The 1.8 cm (0.71 in) plywood structure supports a weight capacity of up to 150 kg. These chairs come fully assembled.



846159 Illiana Chair Small
 Product Size: 310x345x250/505mm
 12.2x13.6x10.2/19.9inches
 Package Size: 40.5x30.5x56cm
 15.9x12x22inches
 QTY/CTN: 2pcs

846161 Illiana Chair Medium
 Product Size: 310x345x300/545mm
 12.2x13.6x11.8/21.5inches
 Package Size: 42x32.5x64.5cm
 16.5x12.8x25.4inches
 QTY/CTN: 2pcs

846162 Illiana Chair Large
 Product Size: 310x345x340/645mm
 12.2x13.6x13.4/25.4inches
 Package Size: 44.5x35x70.5cm
 17.5x13.8x27.8inches
 QTY/CTN: 2pcs

NEW!



848140 Sofia Toddler Chair Stackable
 The stable natural plywood structure is perfect for toddlers. It features an ABS plastic seat and backrest with rounded corners and comes fully assembled.
 Product Size: 281x353x390/210mm
 11.1x13.9x15.4/8.3inches
 Package Size: 40.5x30.5x64cm
 15.9x12.0x25.2inches
 QTY/CTN: 2pcs



**200kgs
(440lbs)**
Weight Capacity



Kiga Teacher's Chair (Limited Stock)

87351 (L440 W420 H780/360mm)
17.3x16.5x30.7/seat height 14.2inches

• This chair is designed to allow teachers to sit comfortably at children's level. It features a curved birch plywood seat and back, supported by sturdy metal legs and a frame. The metal frame can support a weight capacity of up to 200kgs (440lbs).



Chairs

**150kgs
(330lbs)**
Weight Capacity



Kiga Chairs (Limited Stock)

87340 (L320 W300 H460/260mm)
12.6x11.8x18.1, seat height 10.2inches

87310 (L320 W300 H530/300mm)
12.6x11.8x20.9, seat height 11.8inches

87320 (L320 W300 H580/360mm)
12.6x11.8x22.8, seat height 14.2inches

87330 (L320 W300 H700/420mm)
15x14.6x27.6, seat height 16.5inches

87360 (L320 W300 H740/460mm)
15x14.6x29.1, seat height 18.1inches

• Sturdy metal frame structure of 150kgs (330lbs) weight capacity.



Happy Resin Chairs (Limited Stock)

■ Slate

■ Almond

85910 (L405 W340 H455/240mm)

15.9x13.4x17.9, seat height 9.4inches

85920 (L430 W345 H505/300mm)

16.9x13.6x19.9, seat height 11.8inches

85930 (L575 W450 H580/345mm)

22.6x17.7x22.8, seat height 13.6inches

85940 (L530 W430 H700/400mm)

20.9x16.9x27.6, seat height 15.7inches

85950 (L560 W430 H760/450mm)

22x16.9x30, seat height 17.7inches

85911 (L405 W340 H455/240mm)

15.9x13.4x17.9, seat height 9.4inches

85921 (L430 W345 H505/300mm)

16.9x13.6x19.9, seat height 11.8inches

85931 (L575 W450 H580/345mm)

22.6x17.7x22.8, seat height 13.6inches

85941 (L530 W430 H700/400mm)

20.9x16.9x27.6, seat height 15.7inches

85951 (L560 W430 H760/450mm)

22x16.9x30, seat height 17.7inches

• Seating height: 240/300/345/400/450mm
9.45/11.81/13.58/15.75/17.72inches



Childproofing Design
Round edges & nonslip legs



Childproofing Design



Reliable Back Support

**150kgs
330lbs**
Weight Capacity

• Stackable school chairs with round edges and non-slip legs. Build with a sturdy 25mm (1 inch) frame, supporting up to 150kg (330lbs) in weight.

Chairs



As a general rule, we recommend a 150-210mm (5.9-8.3inches) gap between the seat height and tabletop to ensure children in each age range can sit comfortably with their feet flat on the floor. While chair and table heights may vary across our range, the following guide will help you choose the right sizes for each room in your classroom.

Age of children	Approximate minimum seat height	Approximate table height
1-2	150mm (5.9inches)	360mm (14.2inches)
2-3	210mm (8.3inches)	400mm (15.8inches)
3-4	300mm (11.8inches)	470mm (18.5inches)
4-6	350mm (13.8inches)	550mm (21.7inches)



CABINETS

The design of Beleduc furniture is child-centered and thoughtfully crafted. The cabinets can divide a room into designated learning spaces, encouraging children to explore, play, and learn. Research shows that sparking a child's curiosity fosters a love of learning and contributes to long-term success.



Available Colors

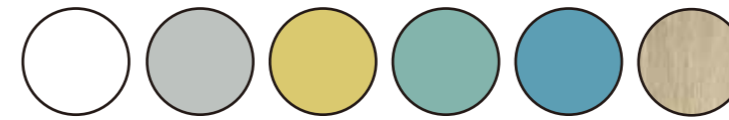

Convenient Storage

The unique open-side design allows easy access to storage, even if one side is blocked.



Flat and strong packaging for international delivery.



The durable plywood board (18mm/.71in) is available in white or a natural wood-colored finish with an HPL anti-scratch and water-proof surface.

Child Protection



Open the door through the opening at the top.



Designed with a safe, slow closing hinge for added protection.

Alternative Bases



Lockable castors (height 72mm/2.83in) sold separately.



Feet come with 2 heights (72mm & 20mm/2.83in & .79in).



*Castors sold separately (846672).

Cabinets with Tray

Pull-out wooden drawer with transparent front and back.

845443



Curved cabinets shape the space with soft lines

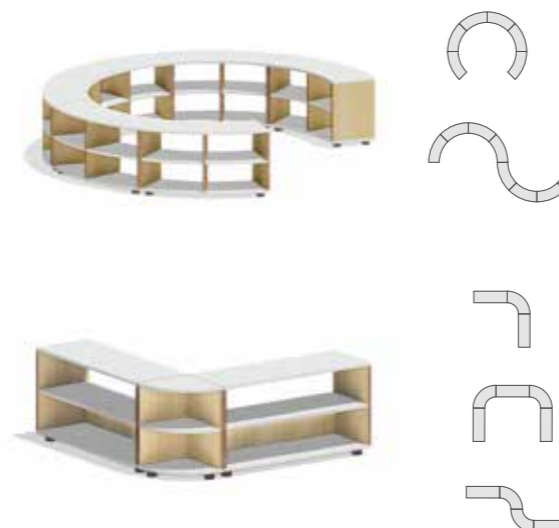

CABINETS OVERVIEW

Beleduc furniture cabinets are thoughtfully designed with intention. Details such as size, number of layers, design, and more can be found in the product list below. The height measurements for each shelf below include 72mm/ 2.83inches for the legs.

Napoli



Torino



Palermo



Roma

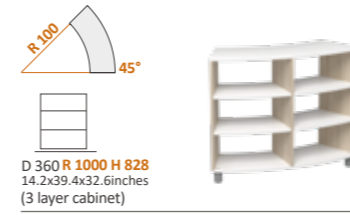
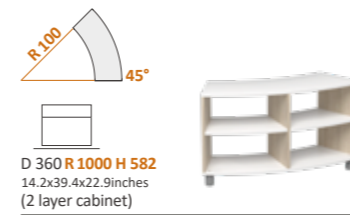

Verona



Genova

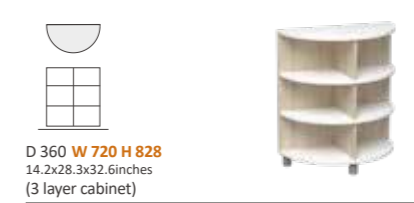

Pisa

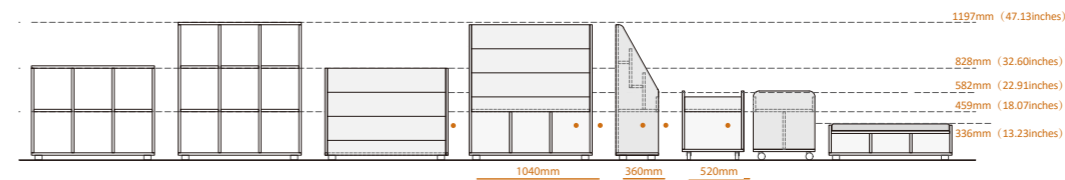

Cabinets

Cabinets



These single layer shelves are designed for the toddler rooms. The lower height allows children to easily take and return their toys or resources independently. They also work great as a room divider. Made of plywood, the shelves feature a modern look with white and natural oak colored, fireproof, and scratch-resistant HPL veneer. An easy-to-follow instruction manual is included, and assembly is required.



846001 Napoli Low Cabinet Wood Storage with Doors
 This 3 storage compartment features doors available in white or grey, and is designed to both display learning materials and provide privacy for storage. The doors are specially designed with a soft-closing mechanism, making it extremely safe, even for use in toddler rooms.
Product Size: 1044x360x459mm
 41.1x14.2x18inches
Package Size: 113x43.5x17 cm
 44.5x17.2x6.7inches
QTY/CTN: 1pc



846003 Napoli 2 Layer Wood Storage Open Wood Storage
 This shelf is accessible from both sides at one column and two locker spaces on the other column. Flexible in classroom set-up as a room divider and display shelf. Detailed instruction manual is provided and assembly is required.
Product Size: 1044x360x828mm
 41.1x14.2x32.6inches
Package Size: 113x45x14.5cm
 44.5x17.8x5.8inches
QTY/CTN: 1pc

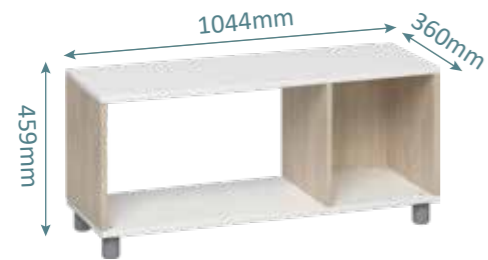

845996 Napoli Low Cabinet Open Wood Storage
Product Size: 1044x360x459mm
 41.1x14.2x18inches
Package Size: 112x43.5x13cm
 44.1x17.2x5.2inches
QTY/CTN: 1pc

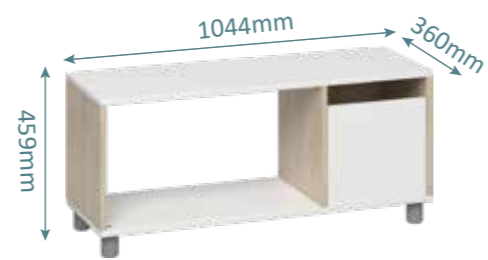

845997 Napoli Low Cabinet Open Wood Storage with White Door
Product Size: 1044x360x459mm
 41.1x14.2x18inches
Package Size: 107.5x39.x10.5cm
 42.4x15.4x4.2inches
QTY/CTN: 1pc

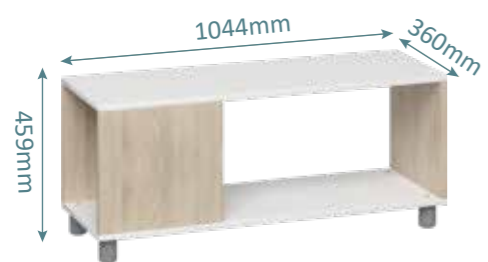

845999 Napoli Low Open End Wood Storage
Product Size: 1044x360x459mm
 41.1x14.2x18inches
Package Size: 112.5x44x12.5cm
 44.3x17.4x5inches
QTY/CTN: 1pc



846000 Napoli Low Compartment Wood Storage
Product Size: 1044x360x459mm
 41.1x14.2x18inches
Package Size: 113x43.5x15cm
 44.5x17.2x6inches
QTY/CTN: 1pc



846004 Napoli 2 Layer Wood Storage with White Doors
Product Size: 1044x360x828mm
 41.1x14.2x32.6inches
Package Size: 106x37x14cm/35.5x35.5x6cm
 41.8x14.6x5.6/14x14x2.4inches
QTY/CTN: 1pc



846006 Napoli 2 Layer Wood Storage Open End
Product Size: 1044x360x828mm
 41.1x14.2x32.6inches
Package Size: 106x37x14cm/35.5x35.5x6cm
 41.8x14.6x5.6/14x14x2.4inches
QTY/CTN: 1pc

This 2 layer shelf is accessible from both sides, with 1 column offering open access and the other featuring 2 closed locker spaces with soft-closing doors available in white and grey finishes. It's a versatile piece, ideal for classroom setups as a room divider and display shelf, while also providing privacy for storing classroom accessories. A detailed instruction manual is included, and assembly is required.



This divider storage unit range is expertly designed to meet a variety of storage and display needs. Made from durable plywood with oak and white veneer, it combines style and sturdiness. An easy-to-follow instruction manual is included, and assembly is required.

These cabinets feature soft-closing doors and are designed to divide the space into 6 or 9 lockers. They are ideal for organizing personal belongings or storing materials for use in future activities. A detailed instruction manual is included, and assembly is required.



846021 Torino Narrow 2 Layer 4 Compartment Wood Shelf
Product Size: 702x360x582mm
 27.6x14.2x22.9inches
Package Size: 78x44.5x18cm
 30.7x17.5x7.1inches
QTY/CTN: 1pc



846007 Napoli 6 Compartment Wood Storage
Product Size: 1044x360x828mm
 41.1x14.2x32.6inches
Package Size: 108.5x41x15.5cm
 42.7x16.1x6.1inches
QTY/CTN: 1pc

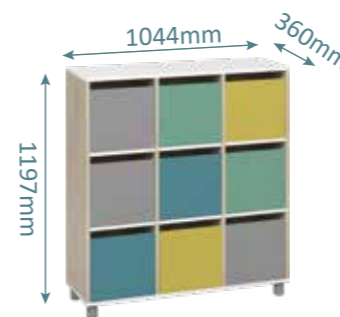

846016 Napoli Tall 9 Compartment Wood Storage with Multi Colored Doors
Product Size: 1044x360x1197mm
 41.1x14.2x47inches
Package Size: 117x41x14.5cm/71.5x37.5x9.5cm
 46.1x16.2x5.8/28.2x14.8x3.8inches
QTY/CTN: 1pc

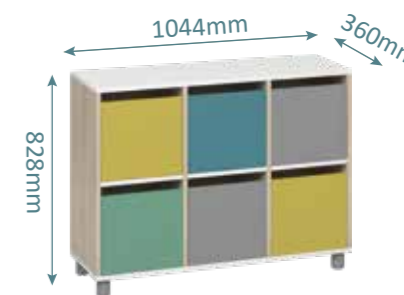

846012 Napoli 6 Compartment Wood Storage with Multi Colored Doors
Product Size: 1044x360x828mm
 41.1x14.2x32.6inches
Package Size: 109.5x41.5x16cm/33.5x13.50x3.5cm
 43.2x16.4x6.3/13.2x5.4x1.4inches
QTY/CTN: 1pc

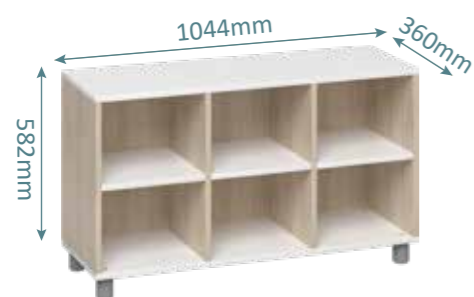

846030 Palermo Low 6 Compartment Wood Storage
Product Size: 1044x360x582mm
 41.1x14.2x22.9inches
Package Size: 108.5x39x14cm
 42.7x15.4x5.5inches
QTY/CTN: 1pc

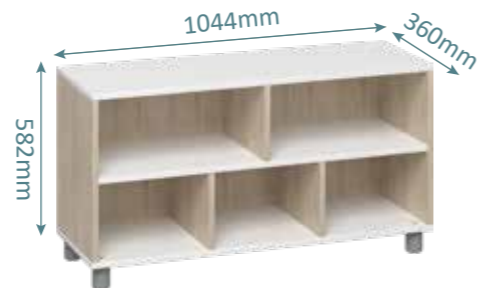

846032 Palermo Low 5 Compartment Wood Storage
Product Size: 1044x360x582mm
 41.1x14.2x22.9inches
Package Size: 108x39.5x14cm
 42.5x15.6x5.5inches
QTY/CTN: 1pc



846014 Napoli Tall 9 Compartment Wood Storage with White Doors
Product Size: 1044x360x1197mm
 41.1x14.2x47inches
Package Size: 15x40x117cm/19.5x37.5x17cm
 6x15.8x46.1/7.7x14.8x6.7inches
QTY/CTN: 1pc



846008 Napoli 25W6 Compartment Wood Storage with White Doors
Product Size: 1044x360x828mm
 41.1x14.2x32.6inches
Package Size: 108x39.5x15cm/35.5x35.5x13.5cm
 42.6x15.6x6/14x14x5.4inches
QTY/CTN: 1pc

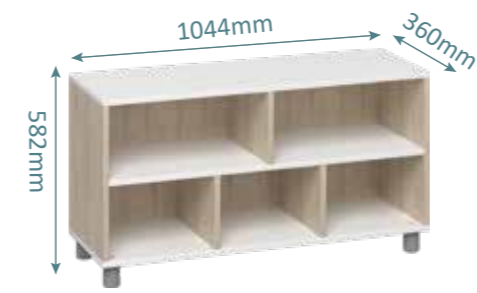

846032 Palermo Low 5 Compartment Wood Storage
Product Size: 1044x360x582mm
 41.1x14.2x22.9inches
Package Size: 108x39.5x14cm
 42.5x15.6x5.5inches
QTY/CTN: 1pc

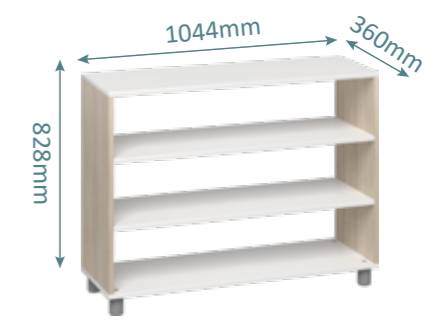

846034 Palermo Mid Height 3 Layer Open Wood Shelf
Product Size: 1044x360x828mm
 41.1x14.2x32.6inches
Package Size: 112x44x14cm
 44.1x17.3x5.5inches
QTY/CTN: 1pc

Designed with simplicity and style in mind, this 2 layer half shelf offers functionality and adaptability to suit any space. Perfect for organizing, displaying, or even dividing a room, it seamlessly enhances the layout of classrooms, playrooms, or learning environments. The unit comes with a detailed instruction manual for easy assembly.



846013 Napoli Tall 9 Compartment Wood Storage
 This tall multifunctional unit combines practicality with modern design, making it ideal for both storage and display. Featuring 9 compartments, it provides ample room for individual storage, perfect for organizing classroom materials or personal items. Crafted from durable plywood with a sleek white and natural oak wood HPL veneer, this unit is both fireproof and scratch-resistant, ensuring longevity and safety in any learning environment. Assembly is required, and a detailed instruction manual is included for easy setup.
Product Size: 1044x360x1197mm
 41.1x14.2x47inches
Package Size: 112x40x14.5cm/35.5x35x18.5cm
 44.1x15.7x5.7/14x13.8x7.3inches
QTY/CTN: 1pc



846018 Torino Narrow 2 Layer Half Open Wood Shelf
Product Size: 702x360x582mm
 27.6x14.2x22.9inches
Package Size: 71.5x37x15cm
 28.1x14.6x5.9inches
QTY/CTN: 1pc



846023 Torino Narrow 3 Layer Open Wood Shelf
Product Size: 702x360x828mm
 27.6x14.2x32.6inches
Package Size: 78.5x44x20cm
 30.9x17.3x7.9inches
QTY/CTN: 1pc

Cabinets

Cabinets

Thoughtfully designed with an open-ended structure visible from both sides. These 2 layer open shelves can also function as room dividers, helping to create distinct open-ended learning spaces within the room. Unique support features ensure the shelf's strong stability. A detailed instruction manual is included, and assembly is required.



846017 Torino Narrow 2 Layer Open Wood Shelf
Product Size: 702x360x582mm
 27.6x14.2x22.9inches
Package Size: 14x40.5x73.5cm
 5.5x15.9x28.9inches
QTY/CTN: 1pc

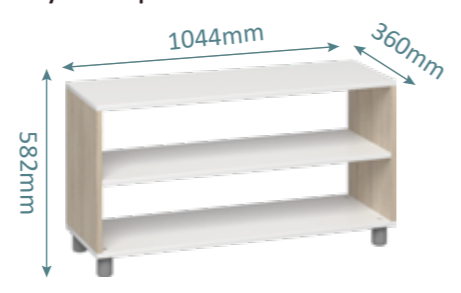

846027 Palermo Low 2 Layer Open Wood Shelf
Product Size: 1044x360x582mm
 41.1x14.2x22.9inches
Package Size: 107.5x9.5x15.5cm
 42.3x3.7x6.1inches
QTY/CTN: 1pc

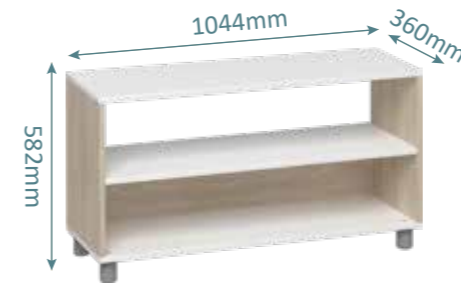

846028 Palermo Low 2 Layer Half Open Wood Shelf
Product Size: 1044x360x582mm
 41.1x14.2x22.9inches
Package Size: 111x44x16.5cm
 43.7x17.3x6.5inches
QTY/CTN: 1pc



846036 Palermo Mid Height 3 Layer Partly Open Wood Shelf
Product Size: 1044x360x828mm
 41.1x14.2x32.6inches
Package Size: 112x44x15cm
 44.1x17.3x5.9inches
QTY/CTN: 1pc



The 2 layer and 3 layer shelving units are perfect for stacking books, displaying learning resources, and serving as room dividers. Made from durable plywood with oak and white veneer, they are easy to clean and resistant to scratches. A detailed instruction manual is included, and assembly is required.



846019 Torino Narrow 2 Layer Closed Wood Shelf
Product Size: 702x360x582mm
 27.6x14.2x22.9inches
Package Size: 73.5x51.5x13cm
 28.9x20.3x5.1inches
QTY/CTN: 1pc



846024 Torino Narrow 3 Layer Closed Wood Shelf
Product Size: 702x360x828mm
 27.6x14.2x32.6inches
Package Size: 76x75.5x10.5cm
 29.9x29.7x4.1inches
QTY/CTN: 1pc



846037 Palermo Mid Height 3 Layer Closed Wood Shelf
Product Size: 1044x360x828mm
 41.1x14.2x32.6inches
Package Size: 76x108x12cm
 29.9x42.5x4.7inches
QTY/CTN: 1pc



846029 Palermo Low 2 Layer Wood Shelf
Product Size: 1044x360x582mm
 41.1x14.2x22.9inches
Package Size: 107x11.5x52cm
 42.1x4.5x20.5inches
QTY/CTN: 1pc

The 2-column and 3-column shelving units are designed with different layers to meet the functional needs of various rooms and age groups. Each shelf can be used individually as a storage locker or paired with our separate drawers (sold separately). These units are perfect for organizing classrooms, providing a neat and efficient storage solution. A detailed instruction manual is included, and assembly is required.



845443 See Through Wooden Tray
Product Size: 310x340x135mm
 12.2x13.4x5.3inches
Package Size: 57x38.5x35.5cm/22.5x15.2x14inches

Wooden tray/bin with high-quality acrylic front and back to allow for visibility of stored materials. Created for individual use and also together with the Beleduc shelving units.



846041 Palermo Mid Height 9 Compartment Closed Wood Storage
Product Size: 1044x360x828mm
 41.1x14.2x32.6inches
Package Size: 108x15x40.5cm/37x16x26cm
 42.5x5.9x15.9/14.6x6.3x10.2inches
QTY/CTN: 1pc



846025 Torino Narrow 6 Compartment Wood Storage
Product Size: 702x360x828mm
 27.6x14.2x32.6inches
Package Size: 181x45x21cm/37x16x26cm
 71.3x17.7x8.3/14.6x6.3x10.2inches
QTY/CTN: 1pc



846026 Palermo Narrow 8 Compartment Wood Storage
Product Size: 702x360x828mm
 27.6x14.2x32.6inches
Package Size: 40.5x76.5x21cm
 15.9x30.1x8.3inches
QTY/CTN: 1pc



846038 Palermo Mid Height 9 Compartment Wood Storage
Product Size: 1044x360x828mm
 41.1x14.2x32.6inches
Package Size: 107.5x39x15.5cm/35.5x12.5x34cm
 42.3x15.4x6.1/14x4.9x13.4inches
QTY/CTN: 1pc



846039 Palermo Mid Height 12 Compartment Wood Storage
Product Size: 1044x360x828mm
 41.1x14.2x32.6inches
Package Size: 108x40x15cm/18.5x35x35cm
 42.5x15.7x5.9/7.3x13.8x13.8inches
QTY/CTN: 1pc

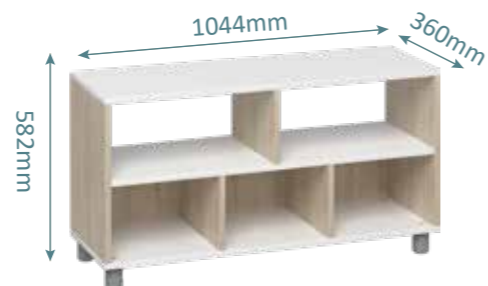

846031 Palermo Low 5 Compartment Half Open Wood Storage
 This low 2 layer shelving unit is divided into 5 compartments—2 with access on both sides for easy use, and 3 with one side open. It can be an excellent add-on solution for creating diverse learning corners in the classroom setup. A detailed instruction manual is included, and assembly required.
Product Size: 1044x360x582mm
 41.1x14.2x22.9inches
Package Size: 108x39.5x14cm
 42.5x15.6x5.5inches
QTY/CTN: 1pc



846040 Palermo Mid Height 8 Compartment Open Wood Storage
 This 3 layer shelving unit is divided into 8 compartments—5 with access on both sides for easy use. It serves as an excellent add-on solution for creating diverse learning corners in the classroom setup. A detailed instruction manual is included, and assembly required.
Product Size: 1044x360x828mm
 41.1x14.2x32.6inches
Package Size: 112x44x11cm/79x44x14cm
 44.1x17.3x4.3/31.1x17.3x5.5inches
QTY/CTN: 1pc

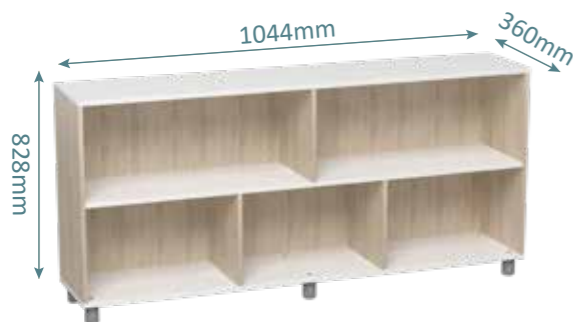

846033 Palermo 5 Compartment Storage Extra Wide Wood Shelf
 This extra wide 5 compartment storage unit is specifically designed to store blocks in the building corner but can also be used to display various types of learning materials in your classroom. Made from durable plywood with oak and white veneer, it combines strength with style. A detailed instruction manual is included, and assembly required.
Product Size: 1044x360x828mm
 41.1x14.2x32.6inches
Package Size: 188x44x95cm/95.5x44x17.5cm
 74.2x17.3x37.4/37.6x17.3x6.9inches
QTY/CTN: 1pc



This curving shelf unit range offers easy access from both sides, designed for display, storage, and as room dividers. The elegant 45 and 90-degree folding angles not only enhance its beauty but also its practicality. This range is perfect for creating a library corner, though it can also fit into various other corner spaces, maximizing the use of every inch. Made from plywood with white and natural oak-colored HPL fireproof and anti-scratch veneer, it features a modern look. A detailed instruction manual is provided, and assembly is required.

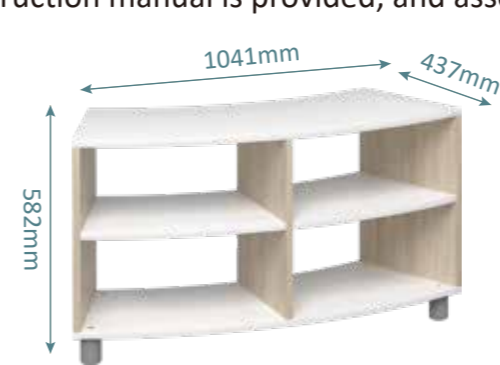

846046 Roma Low Curved Wood Shelf
Product Size: 1041x437x582mm
 41x17.2x22.9inches
Package Size: 111.5x54x17cm
 43.9x21.3x6.7inches
QTY/CTN: 1pc



846048 Roma Mid Height Curved Wood Shelf
Product Size: 1041x437x828mm
 41x17.2x32.6inches
Package Size: 114x57x19cm
 44.9x22.4x7.5inches
QTY/CTN: 1pc

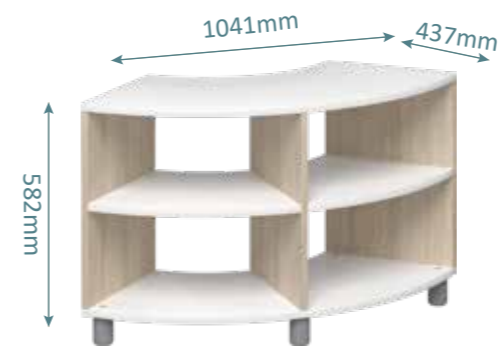

846051 Verona Low Curved Wood Shelf
Product Size: 1041x437x582mm
 41x17.2x22.9inches
Package Size: 109.5x55.5x16.5cm
 43.1x21.9x6.5inches
QTY/CTN: 1pc

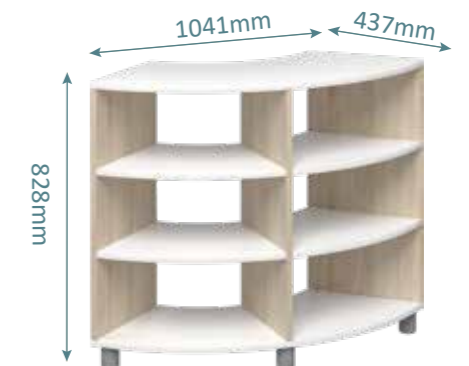

846053 Verona Mid Height Curved Wood Shelf
Product Size: 1041x437x828mm
 41x17.2x32.6inches
Package Size: 109x57x22cm
 42.9x22.4x8.7inches
QTY/CTN: 1pc



The Pisa range of bookshelves and seating is designed to create functional and comfortable reading corners. Each bookshelf features 3 large pockets for storing books of various sizes. Made of durable plywood, the pieces have a modern design with white and natural oak-colored HPL fireproof and anti-scratch veneer. A detailed instruction manual is included, and assembly is required.

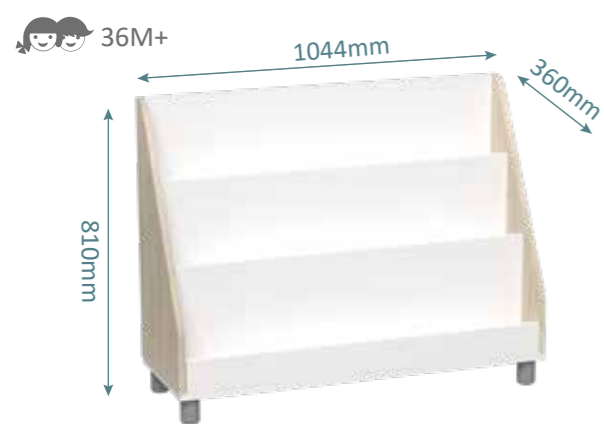

846064 Pisa 3 Pocket Wooden Bookshelf Display
Product Size: 1044x360x810mm
 41.1x14.2x31.9inches
Package Size: 105x40.5x13cm/76x111.x7cm
 41.3x15.9x5.1/29.9x43.7x2.8inches
QTY/CTN: 1pc

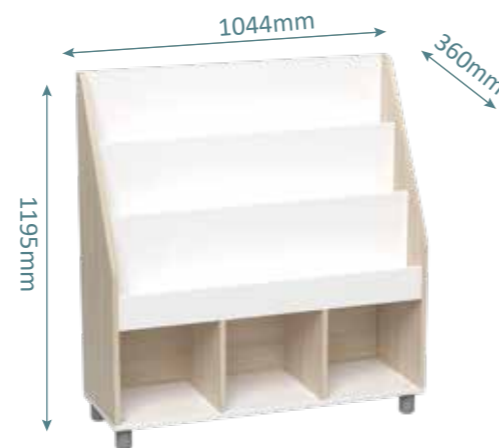

846065 Pisa 3 Pocket Wooden Bookshelf Display with 3 Storage Compartments
Product Size: 1044x360x1195mm
 41.1x14.2x47inches
Package Size: 112.5x40x20cm/102.5x73.5x3cm
 44.3x15.7x7.9/40.4x28.9x1.2inches
QTY/CTN: 1pc



846066 Pisa Wooden Library Cart
Product Size: 520x520x582mm
 20.5x20.5x22.9inches
QTY/CTN: 1pc

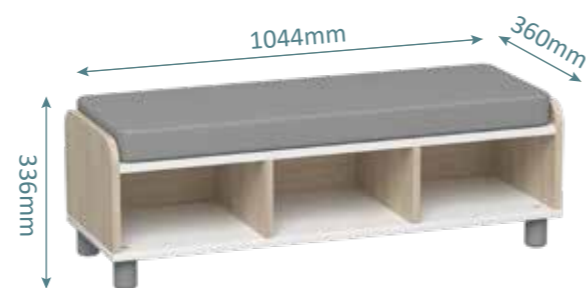

846067 Pisa Wooden Storage Seat
Product Size: 1044x360x336mm
 41.1x14.2x13.2inches
Package Size: 112.5x40x20cm/102.5x73.5x3cm
 44.3x15.7x7.9/40.4x28.9x1.2inches
QTY/CTN: 1pc

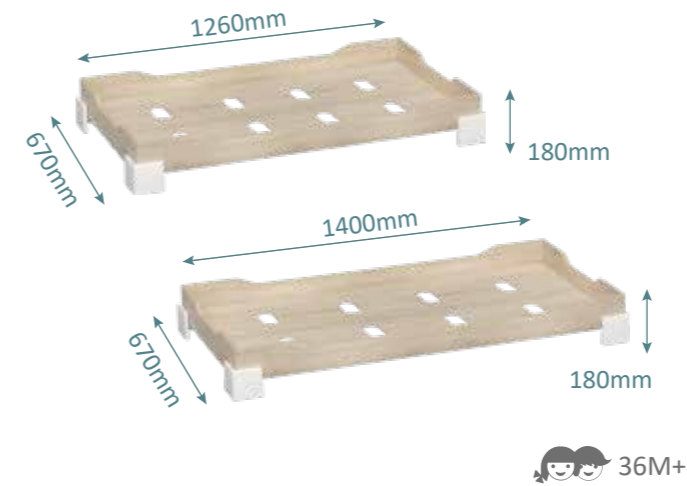

846163 Irene Wooden Cot Small
Product Size: 1260x670x180mm
 49.6x26.4x7.1inches
Package Size: 130x70x22cm
 51.2x27.6x8.7inches
QTY/CTN: 1pc

846164 Irene Wooden Cot Medium
Product Size: 1400x670x180mm
 55.1x26.4x7.1inches
Package Size: 145x70x22cm
 57.1x27.6x8.7inches
QTY/CTN: 1pc

The Irene Wooden Cot

These comfortable children's cots are stackable and easy to handle. They are an excellent space saver for nurseries and kindergartens, and can be stored compactly and accessed easily when needed.

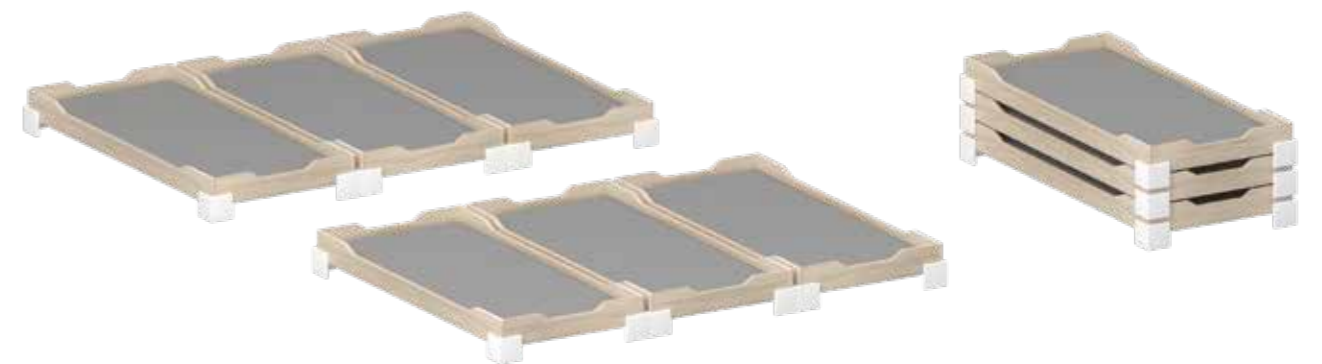



The round corners and semi-circular modules are designed to maximize room space and allow for versatile connections to different learning areas. These modules can be combined with other shelves to create features like an island, a displaying stage, or an "L" shaped room divider. Made from plywood with a modern finish, the pieces feature white and natural oak-colored HPL fireproof and anti-scratch veneer. A detailed instruction manual is provided, and assembly is required.

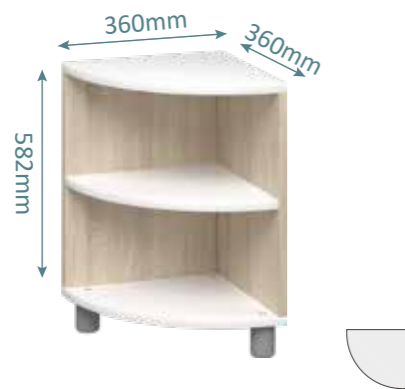

846055 Genova Low 2 Layer Wood Corner Unit
Product Size: 360x360x582mm
 41x17.2x22.9inches
Package Size: 54.5x44.5x15cm
 21.5x17.5x5.9inches
QTY/CTN: 1pc



846056 Genova Low 2 Layer Wood End Unit
Product Size: 720x360x582mm
 41x17.2x22.9inches
Package Size: 80x58x17cm
 31.5x22.8x6.7inches
QTY/CTN: 1pc



846057 Genova Mid Height 3 Layer Wood Corner Unit
Product Size: 360x360x828mm
 14.2x14.2x32.6inches
Package Size: 79.5x45x15.5cm
 31.3x17.7x6.1inches
QTY/CTN: 1pc



846058 Genova Mid Height 3 Layer Wood End Unit
Product Size: 720x360x828mm
 41x17.2x32.6inches
Package Size: 80x80x16.5cm
 31.5x31.5x6.5inches
QTY/CTN: 1pc



These coat hanger cabinets and seating stools can be arranged in various configurations to create functional changing corners. Made from durable plywood, they feature a modern design with white and natural oak-colored HPL fireproof and anti-scratch veneer. A detailed instruction manual is included, and assembly is required.



Bologna 1
846059 (L1044 W360 H282/210mm)
 41.1x14.2x11.1/8.3inches



846059 Bologna 2 Part Wood Locker
Product Size: 1044x360x282/210mm
 41.1x14.2x11.1/8.3inches
QTY/CTN: 1pc

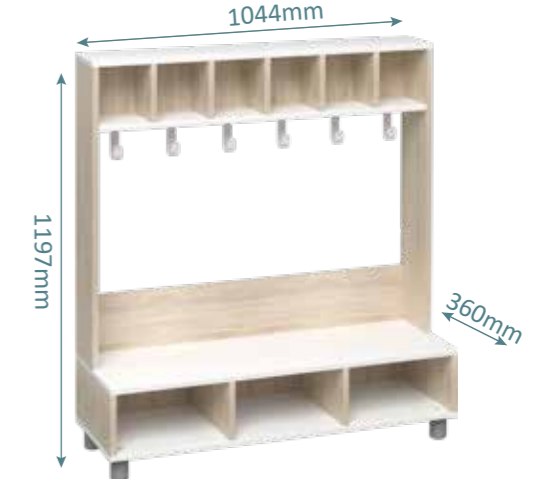

846062 Bologna Free Standing Wood Locker
Product Size: 1044x360x1197mm
 41.1x14.2x47inches
Package Size: 112x44x16.5cm
 44.1x17.3x6.5inches
QTY/CTN: 1pc

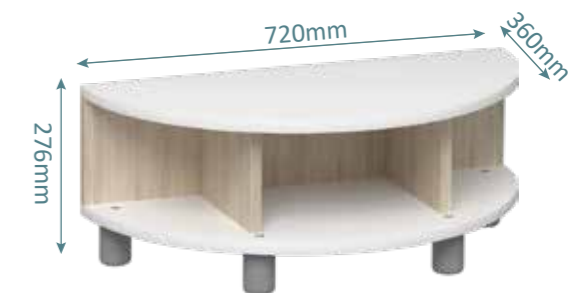

846063 Bologna Low Wood Storage End Unit
Product Size: 720x360x276mm
 28.3x14.2x10.9inches
Package Size: 80x45.5x14cm
 31.5x17.9x5.5inches
QTY/CTN: 1pc

838238 SLEEPING COT GREY

This high-quality sleep cot is ideal for naptime and can be easily stacked for convenient storage. Castors available to purchase for added mobility.

Product Size: 1320x560x125mm
51.9x22x4.9inches

Package Size: 125x30x30.5cm
49.2x11.8x12inches

QTY/CTN: 4pcs

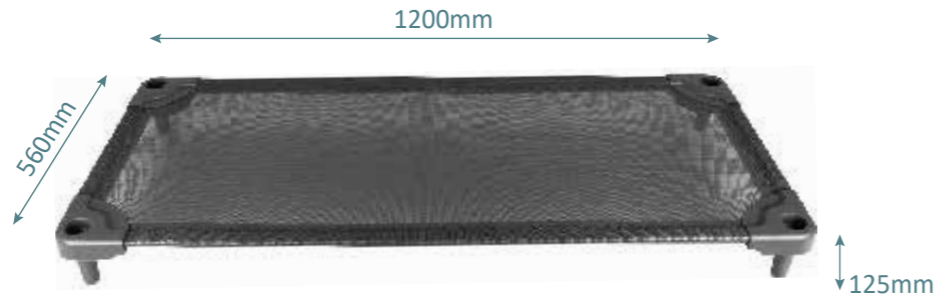

838493 CASTORS FOR SLEEPING COT SET OF 4

Designed to enhance the mobility and convenience of your sleeping cot, these castors allow for effortless movement across various spaces. Their sturdy construction ensures stability while providing smooth rolling functionality. Upgrade your sleeping cot with these durable castors for improved ease of use and versatility.

Product Size: 1.5 inch M8
Package Size: 50x22x28cm
19.7x8.7x11inches

QTY/CTN: 50pcs



The peg mat is constructed from durable PU leather with a 25D PU cotton filter that offers tear resistance, flame retardancy, and stain repellency. For convenient storage, each mat features two plastic-reinforced eyelets at its flat end, enabling easy vertical placement on a specially designed wall rack post-use.

839019 PEG MATS GREY 3CM

Product Size: 903x913x30mm
35.6x35.9x1.2inches

Package Size: 62X5X122cm
24.4x2x48inches

QTY/CTN: 1pc

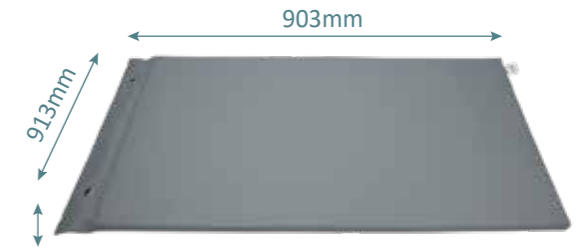

838240 PEG MATS GREY 5CM

Product Size: 1200x600x50mm
47.2x23.6x2inches

Package Size: 62X122X7cm
24.4x48x2.8inches

QTY/CTN: 1pc



838239 CHANGING MAT GREY

This changing mat is specifically designed for frequent use in childcare centers. It features one raised side and one lowered side for easy child access, along with a concave center. The design is tailored to fit perfectly on top of the changing table and is easy to wipe clean for added convenience.

Product Size: 1320x560x125mm
51.9x22x4.9inches

Package Size: 125x30x30.5cm
49.2x11.8x12inches

QTY/CTN: 4pcs

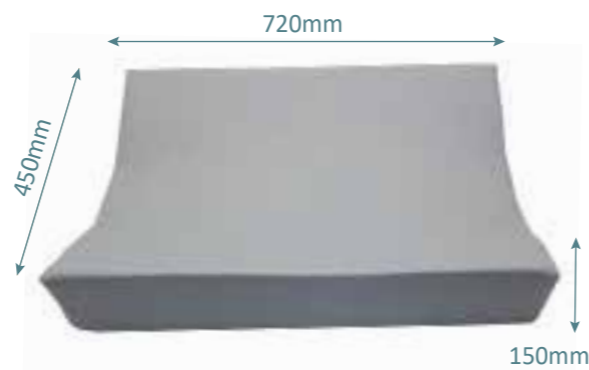

838484 HANGER FOR PEG MATS

Built with premium materials, this durable hanger for peg mats is a space-saving storage solution that enhances both organization and the visual appeal of your space.

Product Size: 700x100x400mm
27.6x3.9x15.7inches

Package Size: 70x11x22.5cm
27.6x4.3x8.9inches

QTY/CTN: 5pcs





This changing table is designed for infants and toddlers, allowing adults to attend to the infants' needs comfortably. It includes a staircase with wheels that children as young as 2 years old can climb independently. The stairs can be stored underneath when not in use. On one side, there is a double-walled cabinet with doors, ideal for storing hygiene and care products. The changing pad is made of 25D foam with soft, non-toxic PU, which can be easily wiped clean with soap and water.

849673 CHANGING TABLE

Product Size: 810x700x1030mm

31.9x27.6x40.6inches

Package Size: 123x90.5x8cm

95.6x64.5x11.5cm

80.5x62x10cm

121x61.5x15.5cm

48.4x35.7x3.1inches

37.6x25.4x4.5inches

31.7x24.4x3.9inches

47.6 x 24.2 x 6.1inches

QTY/CTN: 1pc

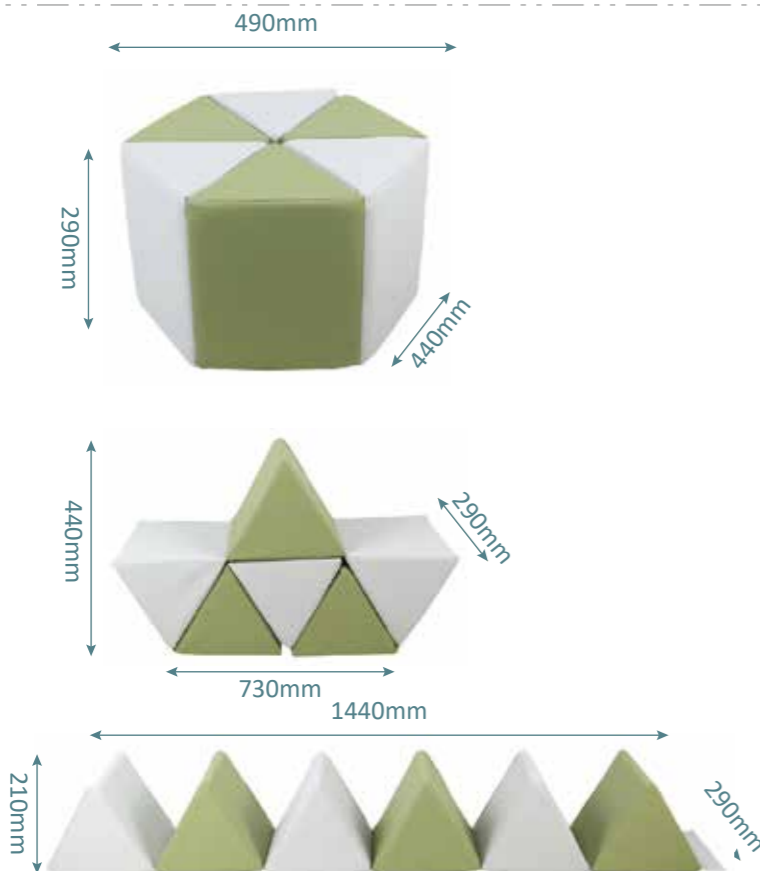

849674 MULTIFUNCTIONAL SENSORY CUSHION

This multipurpose sensory cushion is a tactile toy for children, featuring six equal-sided triangular prisms. When assembled, it functions as both a stool and a rolling hexagonal cube. When opened and flattened, it becomes a play mat, ideal for practicing crawling and straddling. The sensory cube is padded with 25D foam and covered in soft, non-toxic PU, which is easy to clean with soap and water. Perfect for nurseries, preschools, and kindergartens.

Product Size: 490x440x290mm

1440x290x210mm

730x290x440mm

19.3x17.3x11.4inches

56.7x11.4x8.3inches

28.7x11.4x17.3inches

Package Size: 45.5x50.5x61cm

17.9x19.9x24inches

QTY/CTN: 1pc

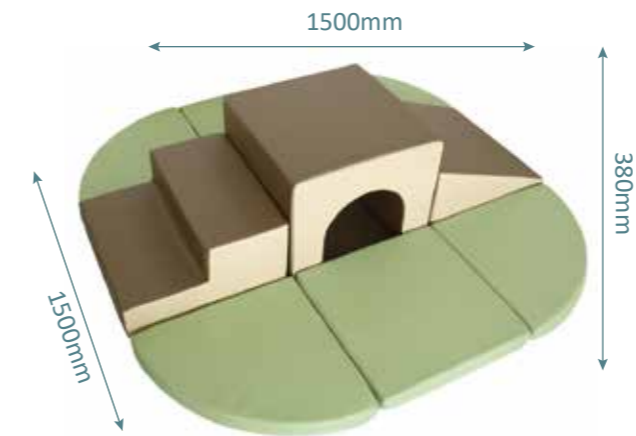

849675 SENSORY CUSHION SET

This well-designed physical activity cushion set helps children reach age-appropriate milestones in a safe, comfortable environment. Filled with 25D dense foam, it is gentle on little elbows and knees. The soft, non-toxic PU cover is easy to wipe clean with soap and water.

Product Size: 1500x1500x380mm

59.1x59.1x15inches

Package Size: 53x52.5x103cm

20.9x20.7x40.6inches

QTY/CTN: 1pc



849676 SENSORY MAT

The sensory mat offers a comfortable surface for individual play or group activities, providing a clean play area for children. The 25D dense foam filling is gentle on little elbows and knees. The soft, non-toxic PU surface is easy to wipe clean with soap and water.

Product Size: 1000x1000x30mm

39.4x39.4x1.2inches

Package Size: 130x53.5x17cm

51.2x21.1x6.7inches

QTY/CTN: 1pc

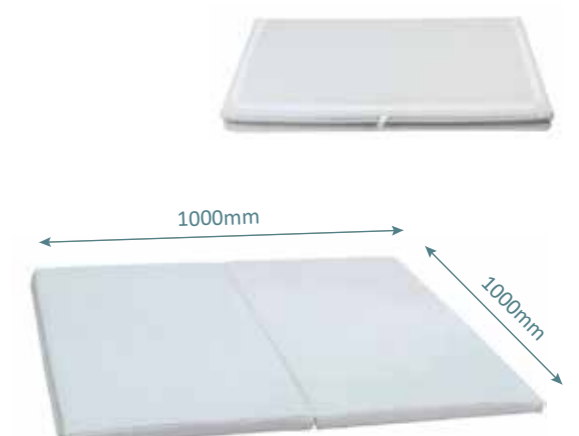



Furniture with various storage containers is essential for any learning center. Paper baskets add a natural touch, helping to create a calm and organized environment. A well-organized room needs these practical storage solutions. Made from paper with a sturdy metal frame.



827337 Rectangular Baskets Small Set of 3
Product Size: 275x175x160mm
 10.8x6.9x6.3inches
Package Size: 66x19x29cm
 26x7.5x11.4inches
QTY/CTN: 4pcs



842506 Rectangular Baskets Big Set of 3
Product Size: 400x110x305mm
 15.7x4.3x12inches
Package Size: 50.3x32x42cm
 19.7x12.6x16.5inches
QTY/CTN: 4pcs



830230 TRIANGLE MIRROR
 Designed to explore the effects of reflection, this unit features one blackboard and one magnetic whiteboard on the outside, offering additional opportunities for various activities.
Product Size: 1200x600x1050mm
 47.2x23.6x41.3inches
Package Size: 124.5x67x11cm
 49.0x26.4x4.3inches
QTY/CTN: 1pc



B85730 Storage Basket
Product Size: 355x255x210mm
 13.9x10x8.2inches
Package Size: 87x27x37cm
 34.3x10.6x14.6inches
QTY/CTN: 6pcs



B85740 Storage Basket Large
Product Size: 395 x 320 x 230mm
 15.6x12.6x9.1inches
Package Size: 77x31x41cm
 30.3x12.2x16.1inches
QTY/CTN: 4pcs

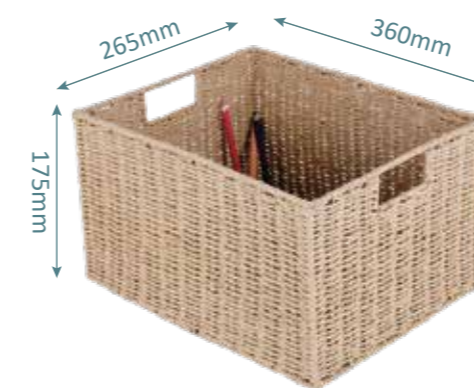

B85750 Storage Basket Medium
Product Size: 360 x 265 x 175mm
 14.2x10.4x6.9inches
Package Size: 59x28x37.5cm
 23.2x11x14.8inches
QTY/CTN: 4pcs



B85800 Storage Basket Cube
Product Size: 340x340x300mm
 13.4x13.4x1.2inches
Package Size: 70.5x70.5x62.5cm
 27.8x27.8x24.6inches
QTY/CTN: 8pcs





B842505 Woven Baskets Round Set of 3
Product Size: 350x90mm
 13.8x3.5inches
Package Size: 56x7x37cm
 22x2.8x14.6inches
QTY/CTN: 6pcs



B85810 Storage Basket Small
Product Size: 340x340x105mm
 13.4x13.4x4.1inches
Package Size: 65x35x36cm
 25.6x13.8x14.2inches
QTY/CTN: 12pcs

A complete set of 3 in 3 sizes. Ideal for storage or transporting items. Made of paper and metal frame.



B85830 Round Basket Set of 3
Product Size: 350x350x200mm
 13.8x13.8x7.9inches
Package Size: 85x35x36cm
 33.5x13.8x14.2inches
QTY/CTN: 4pcs



This plastic tub range is a perfect match for multifunctional shelves. They are also a great storage solution for individual usage.



829015 Transparent Tray 150mm/6inches
Product Size: 370x260x150mm
 14.6x10.2x5.9inches
Package Size: 38.5x27.5x42.5cm
 15.2x10.8x16.7inches
QTY/CTN: 8pcs



829016 Transparent Tray 75mm/3inches
Product Size: 370x260x150mm
 14.6x10.2x5.9inches
Package Size: 38.5x28x35.5cm
 15.2x11.0x14.0inches
QTY/CTN: 8pcs



85230 Sense Path Set of 4
Product Size: 380x430x100mm per box
 14.9x16.9x3.9inches
Package Size: 46.5x41x43cm
 18.3x16.1x16.9inches
QTY/CTN: 8pcs

A set of four hexagonal boxes are ready to be filled with different textures. Sand, grass, leaves, rocks and more! Space them out or have them close together. Great for group work and promotes sensory skills.